

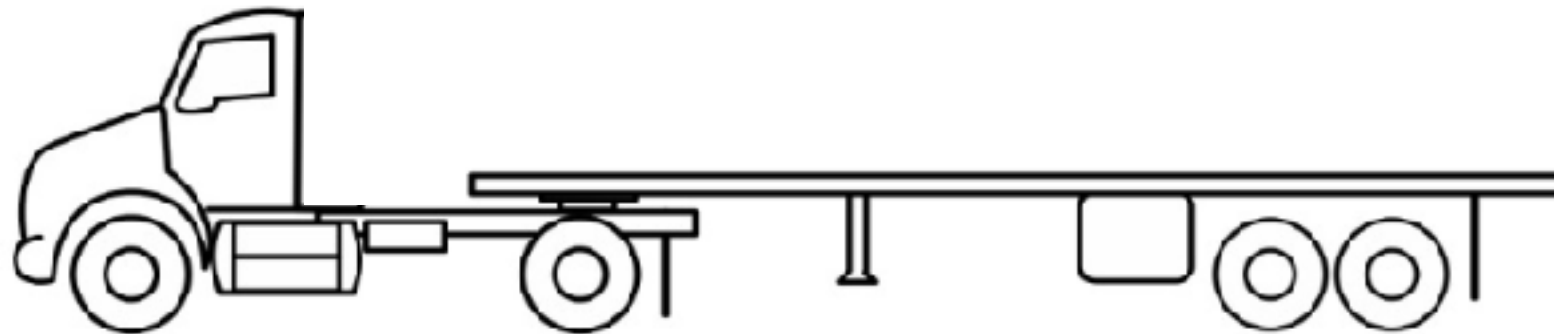



CDL-A Automatic with Air Brakes Road Test Handbook





CDL Road Test Timeline



1 GO TO THE DPS & PAY FOR YOUR CDL
\$37 to \$121
 1 or 2 weeks before your Road Test



But no more than 2 weeks before

2 THE DAY OF YOUR ROAD TEST, GO TO THE DPS WITH THE FOLLOWING DOCUMENTS:

- 1 Proof of US Citizenship or Resident Alien Card or Work Permit (12 months validity)
- 2 Social Security Card (original, not a xerox copy)
- 3 Texas Driver License (must be valid)
- 4 2 forms of Proof of Texas Residency (bill receipts in your name, etc.)
- 5 DOT Medical Card (12 month validity)
- 6 Commercial Learner Permit (CLP) (must be valid)
- 7 DPS Confirmation for your Road Test
- 8 All DPS Receipts





3 PASS THE ROAD TEST
 Just Chill & Relax

- 1 **PRE-TRIP INSPECTION**
- 2 **BACKING MANEUVERS**
- 3 **DRIVING**



4 GET YOUR Commercial Driver License



Anatomy of the Road Test

1 PRE-TRIP INSPECTION

- 1 Walk-up Approach
- 2 Engine Compartment / Passenger Area
- 3 Engine Compartment / Driver Area
- 4 Side & Rear of Truck Area
- 5 Coupling Area
- 6 Trailer Area
- 7 External Lights Area
- 8 Inside of Cab
- 9 Air Brakes Test
- 10 Brake Tug Test



2 BACKING MANEUVERS

- 1 Straight Line Backing
- 2 Offset Backing Left Lane
- 3 Offset Backing Right Lane
- 4 Parallel Parking Passenger Side
- 5 Parallel Parking Driver Side

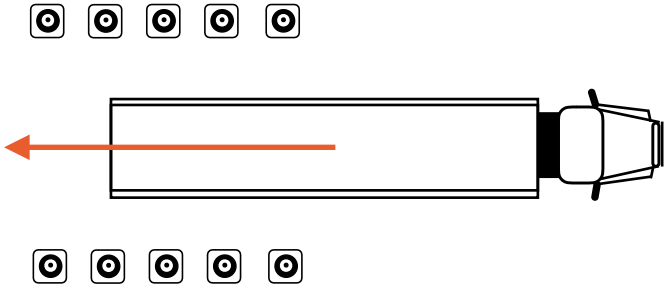

3 DRIVING

- 1 Roadside Stop / Start
- 2 Railroad Crossings
- 3 Speed Limit & Bridge Clearance Signs

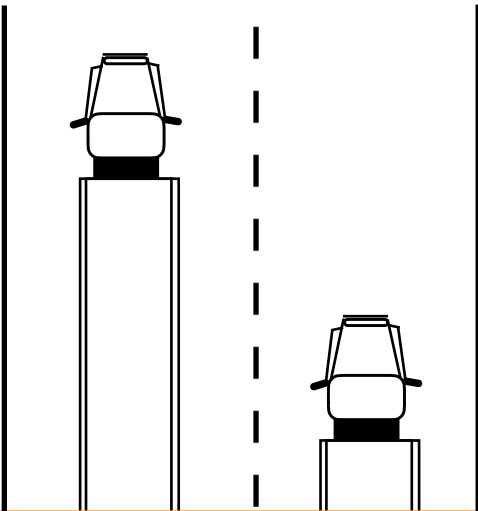



Pre-Trip Inspection

1 WALK-UP APPROACH



2 ENGINE COMPARTMENT / PASSENGER AREA



3 ENGINE COMPARTMENT / DRIVER AREA



4 SIDE AND REAR OF TRUCK AREA



5 COUPLING AREA



6 TRAILER AREA

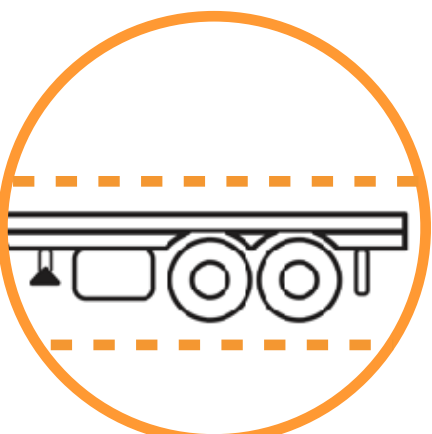

7 EXTERNAL LIGHTS AREA



8 INSIDE OF CAB



9 AIR BRAKES TEST

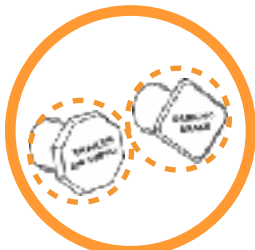

10 BRAKE TUG TEST

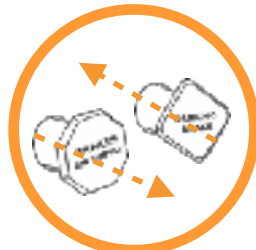

During the PRE-TRIP INSPECTION, you must show that the vehicle is safe to drive. You will have to walk around & point to or touch each item & explain to the examiner what you are checking & why. You should be able to identify each part & tell the examiner what you are looking for or inspecting.

GOOD LUCK

Pre-Trip Inspection Terminology

- **ABCD** - Abrasions, Bulges, Cuts, Dry rot

If it's rubber. If it has fluid/air going through it or in it. Not leaking.

- **CBB** - Cracked, Bent, Broken

If it's metal or some other hard surface.

- **PMS** - Properly Mounted, Secure

If it's mounted (almost everything).

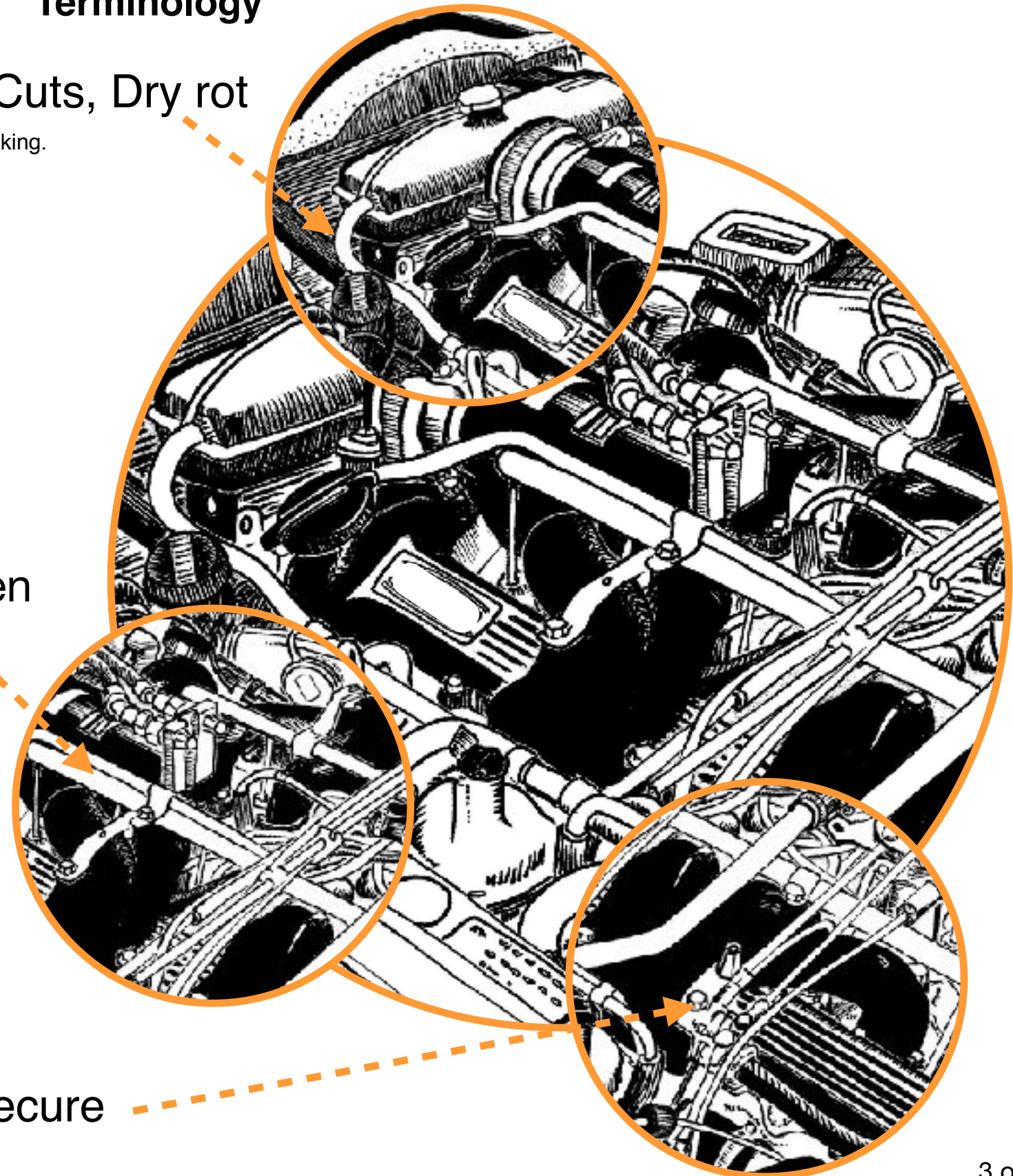



Pre-Trip Inspection Study Guide

1 WALK-UP APPROACH

1.1 PARTS OF THE TRUCK

- Lights and Reflectors.** (PMS) Amber color. Not cracked or broken. None missing.
- Check **Windshield, Hood Mirrors & License Plate** (PMS) and not (CBB).
- Make sure component(s) are operating properly, not leaking and (PMS).

1.2 LEAKS

- No puddles on the ground.
- No dripping fluids on underside of engine. Oil / Brake Fluid / Coolant
- Don't lean, just point.



2.3 FUEL TANK

- Tank(s) are secure, cap(s) are tight, and there are no leaks coming from tank(s) or lines. (PMS). Not (CBB). Straps have no metal to metal contact. Rubber insert. No (ABCD).

3 ENGINE COMPARTMENT / DRIVER AREA

3.1 COOLANT LEVEL

- Reservoir sight glass, (PMS) with no missing bolts, no leaks. At right level.
- Fluid lines are not leaking and both ends mounted securely with no (ABCD).

3.2 WASHER FLUID

- Reservoir sight glass, securely mounted with no missing bolts, no leaks, properly mounted and secure. At Right level.
- Fluid lines are not leaking and are mounted securely with no (ABCD).

3.3 OIL DIPSTICK

- Take Oil Dipstick out, wipe it off, reinsert it & pull it back out. Check oil level. Oil level should be between the add and the full mark. Not (CBB). No leaks.

3.4 AIR COMPRESSOR

- Securely mounted, no missing bolts. Gear driven. No leaks.
- Air Lines properly mounted not (CBB). No leaks.

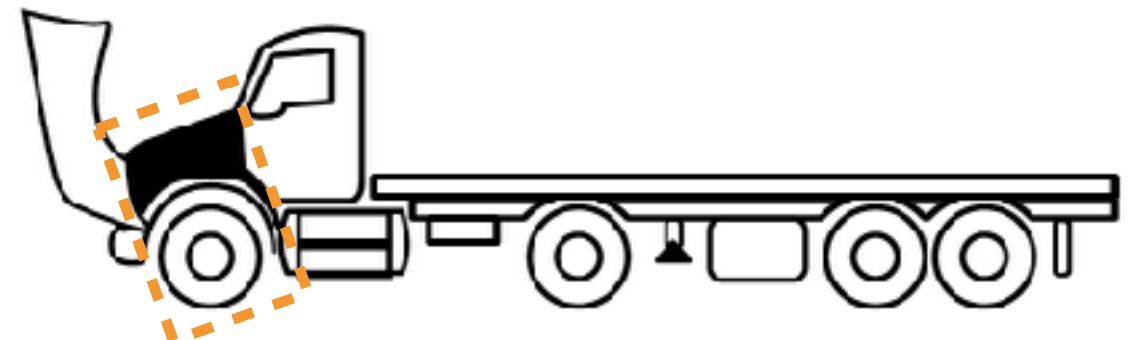

2 ENGINE COMPARTMENT / PASSENGER AREA

2.1 WATER PUMP

- (PMS) with no missing bolts, no leaks. Cables and hoses are tight. Not (CBB). Belt driven no more than 3/4" slack on belt, and not craked or frayed.
- Fluid lines have no (ABCD) or leaking and are (PMS) on both ends.

2.2 ALTERNATOR

- You must tell the examiner which component(s) are not belt driven.
- (PMS) with no missing bolts, cables tight. No cut / exposed wire.
- Belt driven. No more than 3/4" slack on belt. Belt not cracked or frayed.

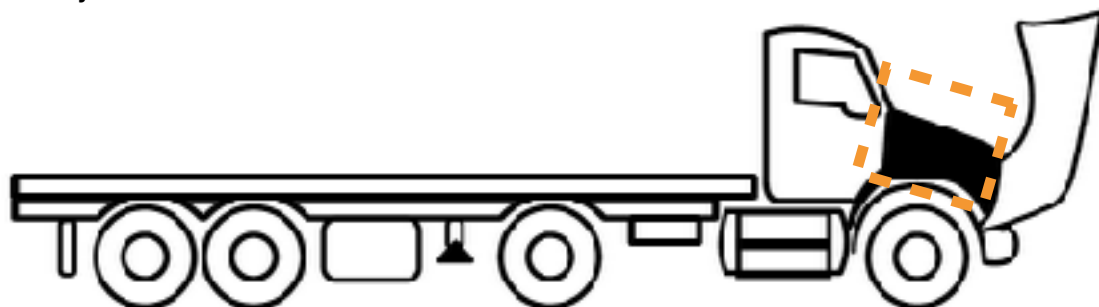

3.4 POWER STEERING PUMP

- (PMS) with no missing bolts, no leaks. Not (CBB).
- Fluid lines are not leaking and are (PMS) with no (ABCD).
- Gear driven.

3.5 POWER STEERING FLUID

- Indicate where power steering fluid dipstick is located. (PMS). At right level. Not (CBB).
- Hoses no (ABCD). No leaking.
- Fluid level must be above refill mark. Not leaking.

3.6 STEERING BOX / HOSES

- Check that the steering box is (PMS) and not leaking. No missing bolts. Not (CBB).
- No power steering fluid leaks or power steering hoses.

3.7 STEERING LINKAGE

- Pitman Arm** - (PMS). Not (CBB).
- Drag Link** - (PMS). Not (CBB).
- Tie Rod** - (PMS). Not (CBB).
- Joints and Sockets** - Not worn or loose with no missing nuts, bolts, or cotter keys.

3.8 SUSPENSION

- Leaf Spring Mounts** - (PMS) not (CBB).
- Leaf Springs** - (PMS). Not (CBB), not shifted or missing leaves.
- U-bolts** - (PMS). Bolts are tight and not (CBB).
- Shocks** - (PMS). Not leaking. Not (CBB).
- Hoses** - (PMS). Tight, no leaks. Not (ABCD).
- Brake Chamber** - (PMS). No dents. Not (CBB) and securely mounted. No leaks. No missing clamp.
- On all parts** - No missing clamps.
- Slack Adjuster** - (PMS). 90-degree angle, no more than 1" of play on the pushrod, brakes released and cotter keys in place. No damage to pushrod. Not (CBB).
- Brake Drum** - (PMS). Not (CBB). No dents or holes, debris or grease, and no missing parts. No blue color (meaning overheating).
- Brake Shoes** - (PMS). No less than 1/4" pad. No missing pad.
- Rims** - (PMS). Not (CBB), no welds or repairs. No rust.

- Tires** - (PMS). No less than 4/32" of tread. No damage to sidewalls. No (ABCD). Proper air pressure and no debris between tires. Evenly worn.
- Lug Nuts** - (PMS). All in place, tight. No slipping or shiny threads. No rust streaks.
- Hub Seals** - (PMS). No leaks and at proper level. Not (CBB).
- Valve Caps and Stems** - (PMS). Caps not missing. Not (CBB). Not leaking.
- Proper Air Pressure** to manufacturers specifications. Check with air gauge.

4 SIDE AND REAR OF TRUCK AREA

4.1 DOOR(S) / MIRROR(S) / STEPS

- Check that door(s) are (PMS) and that they open and close properly from the outside. Not (CBB).
- Hinges should be secure with seals intact. Not worn, torn or dry rot. (PMS). Not (CBB).
- Check that mirror(s) and mirror brackets are not cracked or broken and are (PMS) with no loose fittings.
- Steps. Secure, no missing bolts, not (CBB). Side light not cracked, broken or missing and proper amber color. (PMS).

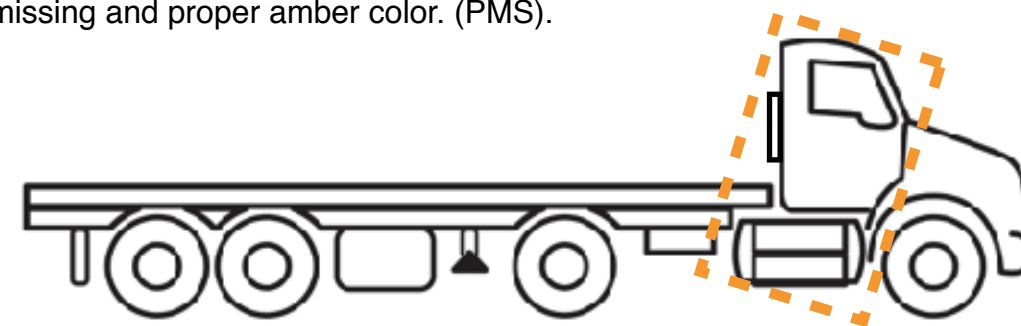

4.2 SAFETY BAR

- (PMS). Not (CBB).

4.3 DRIVE SHAFT

- Drive Shaft** - (PMS). Not (CBB). No debris or foreign objects.
- U-Joint** - (PMS). Not (CBB). Tight.

4.4 EXHAUST SYSTEM

- Not (CBB). No signs of leaks such as rust or carbon soot. Connected tightly and (PMS).

4.5 FRAME

- No cracks, broken welds, holes. Not (CBB). No missing cross members. (PMS).

4.6 CATWALK / STEPS (If equipped)

- Check that the catwalk is solid, clear of objects, and securely bolted to tractor frame. (PMS).
- Steps are securely bolted to tractor frame. No missing bolts. Not (CBB). (PMS).

4.7 QUARTER FENDER OR SPLASH GARD (If equipped)

- (PMS). Not (CBB).

4.8 REAR AXLES

- Torque Arms** (If equipped) - both ends (PMS). Not (CBB).
- Leaf Spring Mounts** - (PMS). Not cracked or broken at both ends.
- Leaf Springs** - Not cracked, broken. No missing or shifted leaves.
- U-bolts** - (PMS) and bolts are tight. Not (CBB).
- Shocks** (If equipped) - (PMS). Not leaking. Not (CBB).
- Air Bags** (If equipped) - (PMS). No leaks, no (ABCD).
- Air Bag Mounts** - (PMS). (If equipped) - not (CBB). Top and bottom.
- Hoses** - (PMS). Tight, no leaks, no (ABCD).
- Chamber** - (PMS). No dents. cracks. No leaks. Not (CBB). No missing clamps.
- Slack Adjuster** - (PMS). 90-degree angle, no more than 1" of play on the pushrod, brakes released and cotter keys in place. Not (CBB).
- Brake Drum** - (PMS). No cracks, dents or holes. No debris or grease and no missing hardware.
- Brake Shoes** - (PMS). No less than 1/4" pad. No missing pad. Not (CBB).
- Rims** - (PMS). Not (CBB). No welds or repairs. No rust.
- Tires** - No less than 2/32" of tread. Evenly worn. No (ABCD). Proper air pressure.
- Budd Spacing** - Evenly centered, with wheels evenly separated. No debris.
- Lug Nuts** - (PMS). Not missing, free of cracks and distortions, and show no signs of looseness such as rust trails or shiny threads. Not (CBB).
- Axles Seals** - (PMS). At proper level. No leaks. Not (CBB).
- Valve Caps and Sterns** - (PMS). Caps not missing. Not (CBB). No leaks.

- Proper Air Pressure**

- Mud Flaps** - (PMS). No more that 8" from the ground. No (ABCD).

4.9 REAR OF TRACTOR

- Lights, Reflectors and Reflective Tape** - Not (CBB) or missing and proper red colors. Function: Red Light (Brake / Running Light / Emergency Hazard Lights / Turn Signal).
- Mud Flaps** - Within 8" from the ground. (PMS) No (ABCD).

5 COUPLING AREA

5.1 AIR / ELECTRIC LINES ON TRUCK AND TRAILER

- Listen for air leaks. Check service (blue) and emergency (red) lines. No (ABCD). (PMS) on both ends.
- Check that electrical (green) line at both ends not dry rot (steel braid should not show through). Not cut. (PMS).
- Make sure air and electrical lines are not tangled, pinched, or dragging against tractor.
- Proper clearance between trailer and cab of tractor for turns.

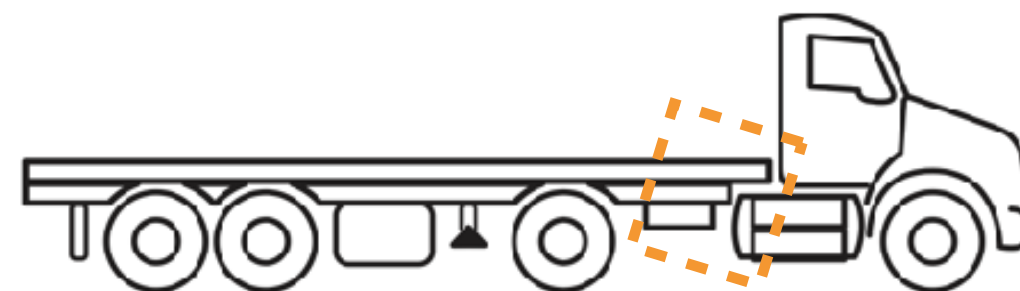

5.2 GLAD HANDS

- (PMS). Not (CBB). Seals in good condition. Not cut or leaking.

5.2 MOUNTING BOLTS

- (PMS). Not missing. Not (CBB). Solidly attached to frame.

5.3 LOCKING JAWS

- (PMS). Look into fifth wheel gap and check that locking jaws are fully closed around the kingpin. Not (CBB).

5.4 FIFTH WHEEL SKID PLATE

Not (CBB). Check for, proper lubrication and that 5th wheel skid plate is (PMS) to the platform and that all bolts and pins are secure and not missing.

5.5 PLATFORM (FIFTH WHEEL)

(PMS). Check for cracks or breaks in the platform structure, which supports the fifth wheel skid plate.

5.6 RELEASE ARM (FIFTH WHEEL)

Not (CBB). Make sure the release arm is in the lock position and the safety latch is in place.

5.7 KINGPIN / APRON / GAP

- Check that the kingpin is not (CBB). (PMS).
- Make sure the visible part of the apron is not (CBB). (PMS).
- Check that the trailer is laying flat on the fifth wheel skid plate (no gap).

5.8 LOCKING PINS (FIFTH WHEEL) (If equipped)

- Check for missing pins.
- Check that the fifth wheel is positioned properly so that the tractor frame will clear the landing gear during turns.
- Proper clearance between back of tractor and landing gear. Not (CBB). (PMS).

6 TRAILER PRE-TRIP AREA

6.1 FRONT WALL

No cracks or holes. Lights and reflectors are in place and proper amber colors. Not (CBB). (PMS).

6.2 SIDE OF TRAILER

Side wall. Lights and reflectors in place, not cracked, broken or missing and proper amber colors. ABS light (if equipped). (PMS).

6.3 LANDING GEAR

Fully raised, has no missing parts. Crank handle is secure not (CBB) and (PMS). Support frame ribs are not (CBB) and (PMS).

6.4 TRAILER FRAME

Look for cracks, broken welds and holes on the frame, cross members, box, and floor.

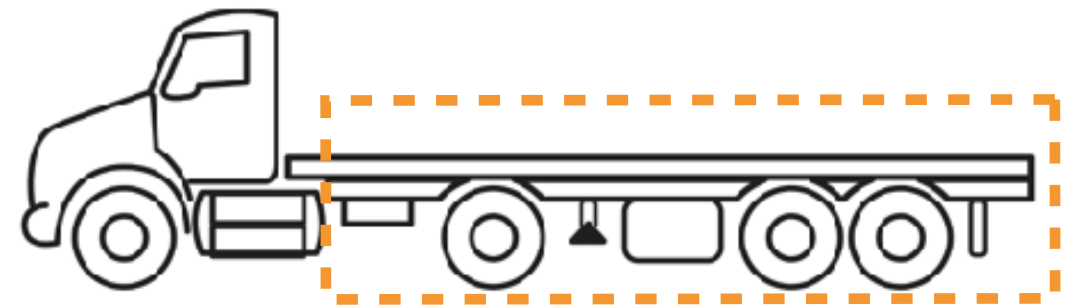

6.5 TRAILER AXLES

- Tandem Release Arm** (If equipped) - in locked position, not (CBB).
- Torsion Bar** (If equipped) - (PMS). Not (CBB).
- Leaf Spring Mounts** - (PMS). Not cracked or broken at both ends.
- Leaf Springs** - (PMS). not cracked, broken, shifted, or missing a leaf.
- Suspension** - (If equipped). With shocks, air bags and air bags mount.
- U-bolts** - (PMS). Secure and bolts are tight. Not (CBB).
- Hoses** - Tight, no leaks, no (ABCD). (PMS).
- Chamber** - (PMS). No dents. Not (CBB). Not leaks. No missing clamps.
- Slack Adjuster** - (PMS). 90-degree angle, no more than 1" of play on the pushrod, brakes released and cotter keys in place. Not (CBB).
- Brake Drum** - (PMS). no cracks, dents or holes. No debris or grease and no missing parts. No blue color (meaning over heating).
- Brake Shoes** - (PMS). No less than 1/4 "pad. No missing pad.
- Rims** - (PMS). No cracks. No welds or repairs. Not (CBB). No rust.
- Tires** - (PMS). No less than 2/32" of tread. Evenly worn to the side walls or tread. No (ABCD). Proper air pressure and no debris between tires.
- Budd Spacing** - Not bent, not (CBB) or rusted. Evenly centered, with wheels evenly separated. No debris.
- Lug Nuts** - All lug nuts are present, free of cracks and distortions, and show no signs of looseness such as rust trails or shiny threads. (PMS).
- Hub Seals** - No leaks and at proper level. Not (CBB). (PMS).

- Valve Caps and Sterns** - (PMS). Proper Air Pressure. Not missing caps or broken. No leaks. Not (CBB).
- Mud Flaps** (PMS). Within 8" from the ground. No (ABCD).

6.6 TRAILER REAR

- Trailer Lights, Reflectors and Reflective Tape** - (PMS). Proper red color. Not crack, broken or missing. All light red in color.
- License Plate Light** - (PMS). Working properly. Not (CBB) or missing.
- Open Door** (Cointainer Trailer if equipped) - (PMS). Check inside for (CBB).
- Door Seal and Hinges** (Cointainer Trailer if equipped) - In place. Not (CBB). Rubber seal. No (ABCD).
- Door Latches** (Cointainer Trailer if equipped) - (PMS) in bracket. Not (CBB).
- DOT Bumper** - (PMS). Not (CBB).

IF YOU DO NOT MENTION THE LICENSE PLATE LIGHT YOU WILL NOT GET CREDIT FOR TRAILER LIGHTS

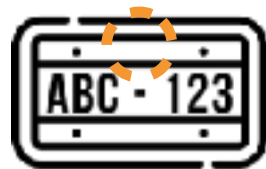

● **ABCD** - Abrasions, Bulges, Cuts, Dry rot ● **CBB** - Cracked, Bent, Broken ● **PMS** - Properly Mounted, Secure

7 EXTERNAL LIGHTS CHECK AREA

Ask DPS examiner to assist in light check (they will not point to any light, only indicate that lights are working). Failure to complete light test correctly, will not give you credit for light check on your Pre-Trip Inspection.

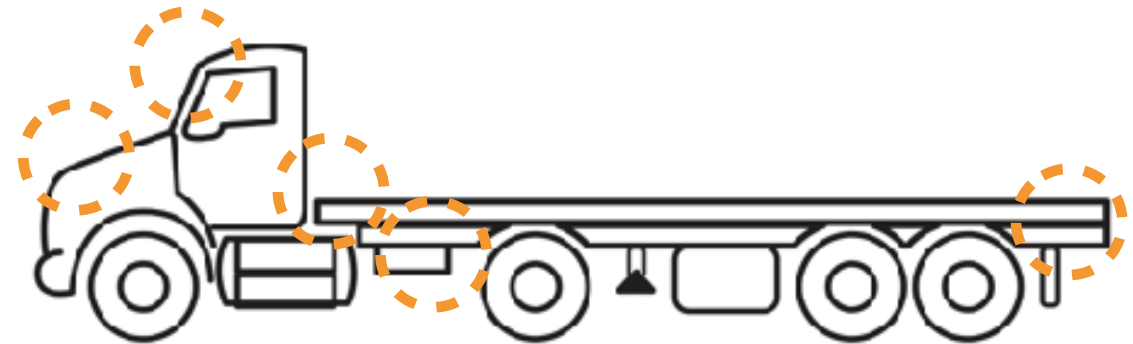

7.1 LIGHT CHECK

- Turned on Headlights** (high and low beams)
- Left Turn Signal**
- Right Turn Signal**
- Hazard Lights**
- Tail lights**
- Turn Signals**
- Brake Lights**
- Anti-lock Braking System (ABS) Indicator**

PRE-TRIP INSPECTION SECTIONS

The day of your Road Test, you will be asked to pick one card at random out of 4 cards, each containing a different section of the truck to inspect. Class A applicants will all have to do coupling and in-cab / brake leak test.

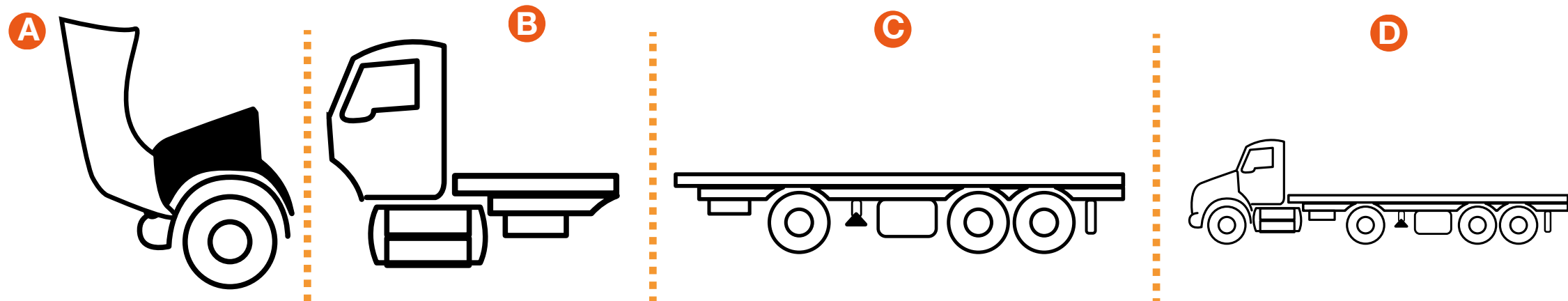

8 INSIDE OF CAB INSPECTION

1

3-POINT ENTRY

- 1 Grab the door handle with your left hand.
- 2 Grab steering wheel with your right hand.
- 3 Right foot in the first step.



2

1 CHOCK TIRES

Wooden chocks found behind driver seat.



2 SEAT BELT

PMS. No Cuts or Frays. Latches properly. Adjust to your size.



3 SPARE FUSES

Present. Inside truck.



4 3 EMERGENCY TRIANGLES

Present. Inside truck. (CB)



5 FIRE EXTINGUISHER

PMS. Fully charged. Properly rated.



6 FLOOR DEBRIS

Check & remove if present.



7 STEERING WHEEL

No more than 10 degrees or 2 inches of play.



8 HORN

Test city & air horn.



9 WINDOWS

PMS. Not Cracked or Broken. Roll them up & down.



10 MIRRORS

PMS. Not Cracked or Broken. Set to driver view and clean.



11 WINDSHIELD

PMS. Not Cracked or Broken. Clean and with no illegal stickers.



12 WINDSHIELD WIPERS

PMS. No CBB. Blade present. No splits or cuts.



3

SAFE START

- 1 Truck in neutral.
- 2 Yellow and red knobs pulled-out.
- 3 Turn ignition key for full start.



4

1 ABS LIGHTS

Come on & off.



2 INDICATOR LIGHTS

Check Blinkers, Hazard Lights, Low Beams, High Beams & Break Lights.

3 TEMPERATURE GAUGE

Rising up to the proper level or at the proper level. No warning lights.



4 OIL GAUGE

At the proper level. No warning lights.



5 FUEL GAUGE

At the proper level.



6 VOLTMETER

At the proper level. No warning lights.



7 AIR GAUGE 1

Rising up to the proper level or at the proper level. No warning lights.



8 AIR GAUGE 2

Rising up to the proper level or at the proper level. No warning lights.



9 HEATER & DEFROSTER

Turn on top & bottom blower.



10 WIPER FLUID

Press button to activate.



11 WINDSHIELD WIPERS

Twist lever to activate.



9 AIR BRAKES TEST / AIR LEAK PROCESS CDL-A

9.1 PREPARATION

1. Chock one tractor wheel.
2. Truck in neutral.
3. Yellow and red knobs pulled-out.
4. Start engine.
(For step 5, you may have to lower tanks to 100 PSI to engage air compressor).
5. 1,300 RPM, charge tanks until you hear a loud explosive noise (120-135 PSI).
6. Turn engine OFF.
7. Turn key to 'ON' position (to get 12 volts to buzzer and red lights).
8. Push-in yellow and red knobs (to release all tractor-trailer brakes).
9. Make sure both knobs are pushed-in completely.

1ST TEST: AIR LEAK TEST WITH ALL BREAKES RELEASED

1. Wait for tanks' pressure to fully stabilize (about 10 seconds).

I HAVE ___ PSI ON TANK 1 AND ___ PSI ON TANK 2.

2. Start timer for 1 minute.

I CAN LOSE 3 PSI ON EACH TANK WITH A TRAILER OR 2 PSI WITHOUT A TRAILER.

3. After 1 minute (or sooner if directed by DPS examiner).

I LOST ___ PSI ON TANK 1 AND ___ PSI ON TANK 2.

4. Verify that you did not lose more than 3 PSI per tank.

2ND TEST: AIR LEAK TEST WHILE APPLYING THE FOOT BRAKE PEDAL

1. Apply the foot brake pedal with MODERATE force and freeze it there.
2. Wait for tanks' pressure to fully stabilize (about 5 seconds).

Call out when tanks stabilize.

3. Start timer for 1 minute.

I CAN LOSE 4 PSI ON EACH TANK WITH A TRAILER OR 3 PSI WITHOUT A TRAILER.

4. After 1 minute (or sooner if directed by DPS examiner).

I LOST ___ PSI ON TANK 1 AND ___ PSI ON TANK 2.

Verify that you did not lose more than 4 PSI per tank.

3RD TEST: LOW AIR PRESSURE RED LIGHTS & ALARM TEST (BETWEEN 60 & 70 PSI)

1. Ensure key is in the "ON" position, so buzzer and red lights get 12 volts.
2. Pump air brakes with brake pedal until red lights & alarm activate (60-70 PSI).

MY RED LIGHTS AND ALARM CAME ON BETWEEN 60 AND 70 PSI.

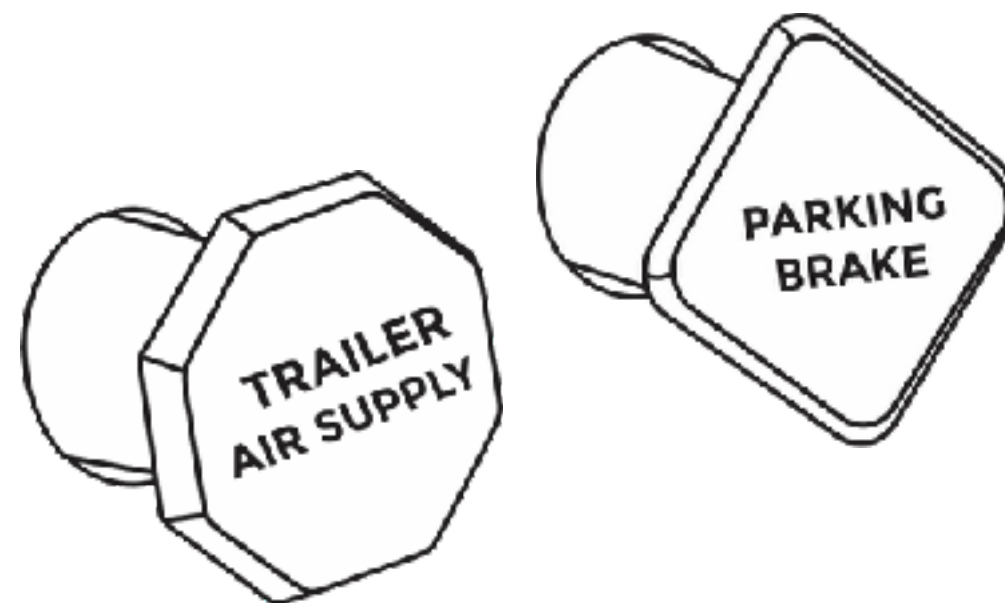

4RD TEST: AUTOMATIC APPLICATION OF EMERGENCY BRAKES (BETWEEN 20 & 45 PSI TEST)

1. Pump brake pedal until red knob pops out.

RED KNOB POPPED OUT BETWEEN 20 & 45 PSI.

2. Pump brake pedal until yellow knob pops out.

YELLOW KNOB POPPED OUT BETWEEN 20 & 45 PSI.

3. Remove wheel chocks.

4. Start engine, allow brake pressure to build up to 120-135 PSI to check governor cut in/out.

10 BRAKE TUG TEST

10.1 TRAILER BRAKE TUG TEST

1. Put truck in neutral with foot on brake.
2. Release brakes.
3. Pull red knob only to apply trailer brakes.
4. Put truck into gear and slowly pull forward. Should feel resistance.
5. Stop.

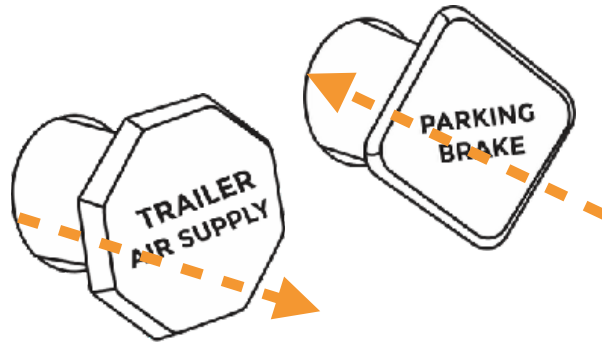

10.2 PARKING BRAKE TUG TEST

1. Put truck in neutral with foot on brake.
2. Release brakes.
3. Pull yellow knob only to apply parking brakes.
4. Put truck into gear and slowly pull forward. Should feel resistance.
5. Stop.

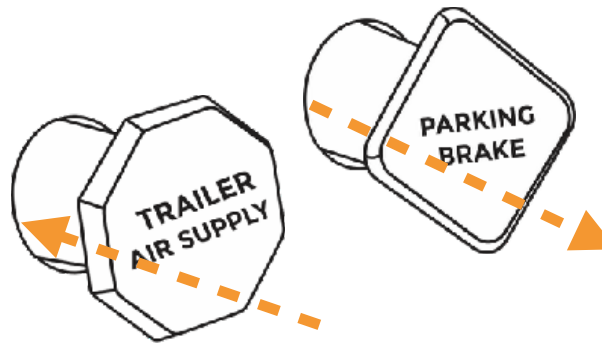

10.3 SERVICE BRAKE (BRAKE PEDAL)

1. Push in the red & yellow knob.
2. Speed up 5 miles per hour.
3. Step on brakes.
4. Make sure the truck does not move to either side.



CDL Vehicle Inspection Memory Aid

Front of Vehicle
Lights/Reflectors, Engine Compartment
& Steering Components

Steering Axle

- Suspension
- Brakes
- Tires

Driver Door Fuel Area

Under Vehicle

- Driver Shaft
- Exhaust
- Frame

Drive Axle(s)

- Suspension
- Brakes
- Tires

Coupling Devices

- Truck
- Trailer

Rear of Truck/Tractor & Lights/Reflectors

Trailer Components Front, Side, Lights & Reflectors

- Frame
- Landing Gear
- Tandem Release

Trailer Axle(s)

- Suspension
- Brakes
- Tires

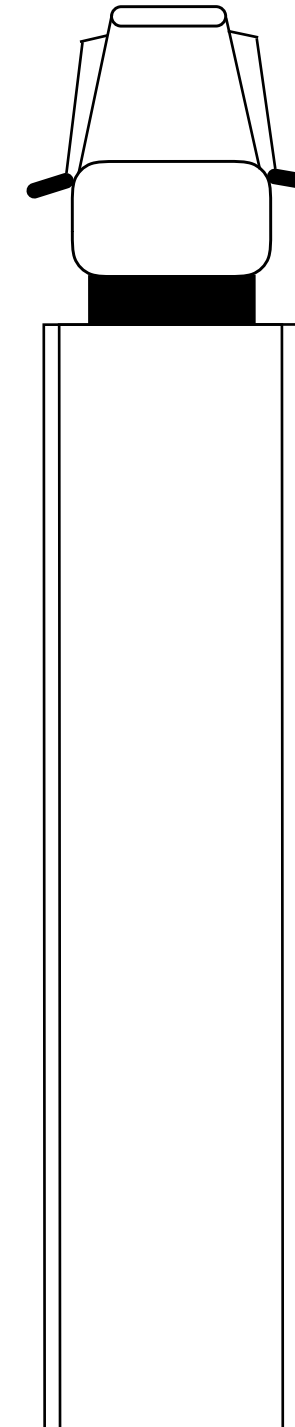

**Rear of Trailer &
Lights/Reflectors**

Backing Maneuvers

1 STRAIGHT LINE BACKING

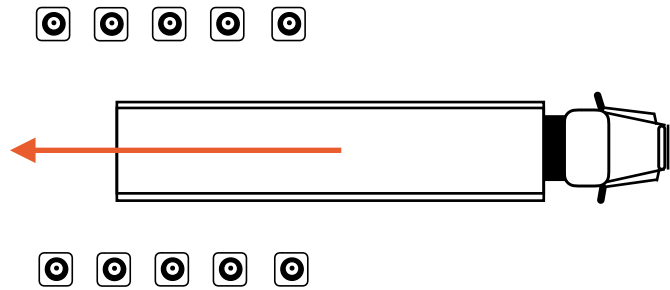

2 OFFSET BACKING LEFT LANE

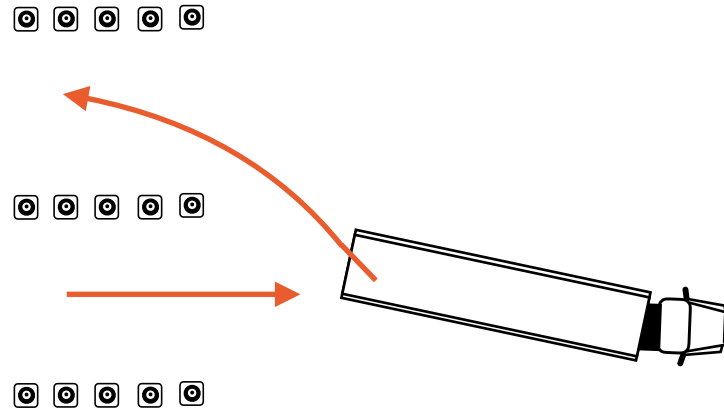

3 OFFSET BACKING RIGHT LANE

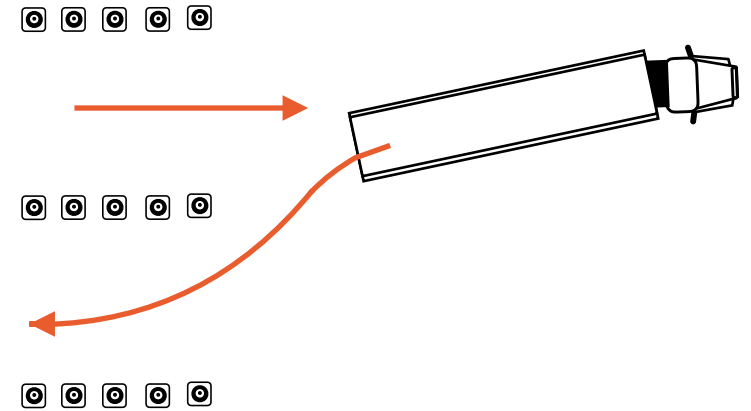

4 PARALLEL PARKING PASSENGER SIDE

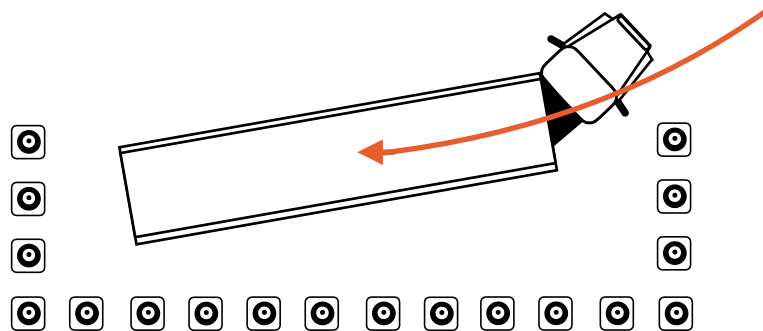

5 PARALLEL PARKING DRIVER SIDE

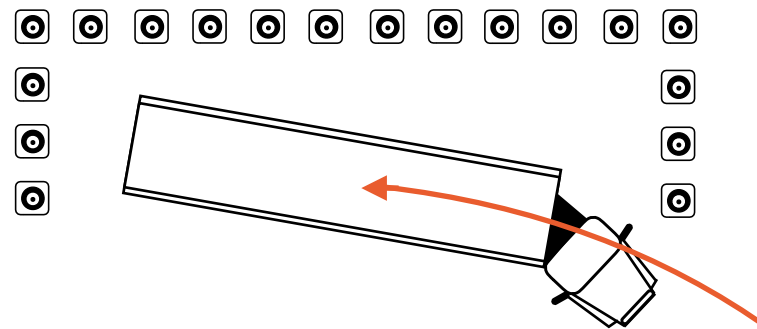

BACKING MANEUVERS FORMULA

DRIVER SIDE	PASSENGER SIDE
1 Right	1 Left
2 Left	2 Right
1 Right	1 Left
1 Left	1 Right
2 Right	2 Left

BASIC RULES FOR TRUCK & TRAILER

A Follows the steering wheel.

B Moves **opposite** from the steering wheel.

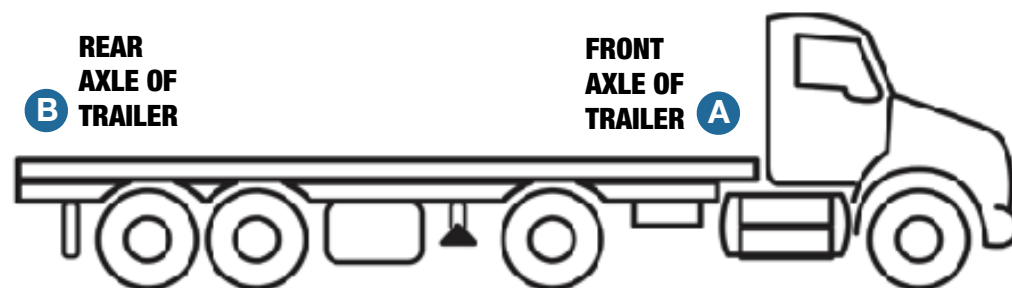

During the BACKING MANEUVERS, avoid hitting any cones or looking out the rear window.

😊 GOOD LUCK

1 ROADSIDE STOP / START

For this maneuver, you will be asked to pull your vehicle over to the side of the road and stop as if you were going to get out and check something on your vehicle.

1.1 ON APPROACH

1. Check traffic thoroughly in all directions.
2. Move to the right-most lane or shoulder of road.

1.2 PREPARING FOR THE STOP

1. Check traffic.
2. Activate your right turn signal.
3. Decelerate smoothly.
4. Brake evenly.
5. Change gears as necessary.
6. Bring your vehicle to a full stop without coasting.



1.3 ONCE STOPPED

1. Vehicle must be parallel to the curb or shoulder of the road and safely out of the flow of traffic.
2. Vehicle should not be blocking driveways, fire hydrants, intersections or signs.
3. Turn your turn signal off.
4. Activate your hazard lights.
5. Apply the parking brake.
6. Move the gear shift to neutral.
7. Remove your feet from the brake and clutch pedals.

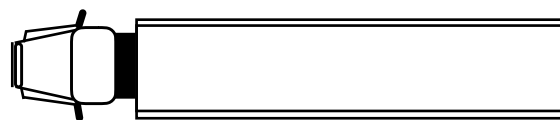

1.4 RESUMING TRIP

1. Check traffic and your mirrors thoroughly in all directions.
2. Turn off your hazard lights.
3. Activate the left turn signal.
4. When traffic permits, release the parking brake and pull straight ahead.
5. Do not turn the wheel before your vehicle moves.
6. Check traffic from all directions, especially to the left.
7. Steer and accelerate smoothly into the proper lane when safe to do so.
8. Once your vehicle is back into the flow of traffic, cancel your left turn signal.

2 RAILROAD CROSSING

Before reaching the crossing, all commercial drivers should:

2.1 ON APPROACH

1. Decelerate.
2. Brake smoothly & shift gears as necessary.
3. Stop the vehicle within 50 feet but no less than 15 feet from the nearest rail.
3. Look and listen for the presence of trains.
4. Check traffic in all directions.



2.2 CROSSING

1. Do not stop.
2. No shifting gears.
3. Do not pass another vehicle, or change lanes while any part of your vehicle is in the crossing.
4. Look for stoppages & outages.
5. Accelerate & do not shift gear until you clear the tracks.

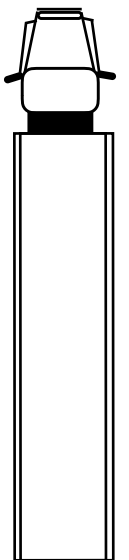

3 SPEED LIMIT & BRIDGE CLEARANCE SIGNS

You will be asked about street speed limits and bridge clearances just after you pass these signs. Take note on them.



MANUAL TRUCK: 10' 8" high.
AUTOMATIC TRUCK: 9' 2" high

X Most Common Mistakes

They can cost you not to take, continue, complete or pass the CDL Road Test, so take a look and try to improve. You will have EXACTLY 1 hour to complete Pre-trip Inspection, Inside Cab Inspections (Air Brakes included) and Maneuvering.

1 BEFORE THE ROAD TEST

1. You didn't pay your CDL (\$37 to \$121) BEFORE the day of your Road Test at the latest (1 to 2 weeks highly recommended).
2. You cannot take Road Test or get your CDL after having passed it because your CDL payment (\$37 to \$121) has expired! Payment is good for 90 days & 3 tries at getting your CDL only!
3. Not having a valid TX Driver License (DL) & a valid TX Commercial Learner's Permit (CLP) the day of your Road Test.
4. Not having passed all 4 required Knowledge Tests (written/computer): Special Requirements-Texas Commercial Rules, General Knowledge, Combination Vehicles & Air Brakes.
5. You or DPS made an error & you got an appointment for the Automobile Road Test instead of a CDL Road Test.
6. DPS examiner won't give you your CDL Road Test because you did not confirm appointment via email or you can't show email confirmation of appointment.
7. You cannot take Road Test or get your CDL after having passed it because you went beyond the required 90 days period to complete all testing.
8. DPS won't give you a RT because you wrote something in arms/hands.
9. Talk with someone after giving the examiner the insurance, registration & DL.



2 ON THE PRE-TRIP INSPECTION

1. You did not adjust the mirrors to your liking before the Road Test.
2. Not knowing where the Registration, State Inspection & Insurance is.
3. Not knowing where the fire extinguisher, fuses & reflective triangles are.
4. Not knowing how to turn 'on' the headlights, high beam / low beam lights, hazard lights, air horn, electric horn, wipers, turn lights, stop lights.



5. You cannot perform the outside Pre-Trip Inspection, Inside Cab Inspection (includes Air Brake System checks) to the satisfaction of the examiner.

3 ON THE AIR BRAKE SYSTEM CHECKS

If the examiner ask you to check Air Brake System WITHOUT STARTING THE ENGINE:

1. Turn the ignition switch to "ON" position.
2. Push red & yellow knobs.
3. Wait for tank air gauges' readings to stabilize.
4. Read the tanks and start timer for one minute.
5. You will know the rest before you take your Road Test.
6. When checking for air leaks with the service brakes applied, apply STEADY MODERATE pressure to brake pedal!



4 ON THE BACKING MANEUVERS

1. You cannot start the engine because you didn't engage the clutch.
2. You cannot move the Truck-Trailer because you can't release the brakes.
3. You cannot properly perform the Backing Maneuvers (Straight Line Backing, Parallel Parking or Offset Backing) to the satisfaction of the examiner.
4. You cannot Parallel Park the Tractor-Trailer to the driver or passenger side to the satisfaction of the examiner. Don't touch the curb and don't jackknife the Tractor-Trailer!



5 ON THE DRIVING

1. Not driving defensively, not paying attention to your surroundings always.
2. Speeding or driving too slow.
3. Touching curb when making turns.
4. Touching the continuous white line.
5. Grinding gears when shifting gears.
6. You cannot drive the route to the satisfaction of the examiner.
7. Examiner stops the test because you took too long to complete part of it.



It's ok to be nervous before your Road Test, that's why we share with you some tips so that you can rock that day.

1 TELL YOURSELF YOU ARE READY

You wouldn't be taking your driving test if you weren't good enough to pass it. Knowing you're just doing something you've done before many, many times before can really help.



2 KEEP IT A SECRET

Don't tell everyone you're taking your test. Keeping quiet about it takes some of the pressure off, so only tell the people you want or need to tell.

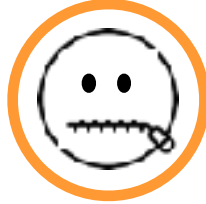

3 DON'T SKIP MEALS

Eating might be the last thing on your mind but without food, you don't have the brain fuel you need for your test. Eating something before your test will help you concentrate.



4 PRETEND IS A PRACTICE TEST

The examiner may be holding a clipboard but try to regard this as just a practice test. You'll still put in your best performance but you're less likely to panic about it all going wrong. Remember: no one is asking you to do anything you haven't already done in your lessons.



5 GET ENOUGH SLEEP

Don't stay late studying the night before your RT. Instead, go to bed early and get 6-8 hrs of sleep so that you are well-rested and relaxed.

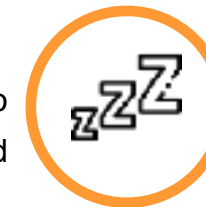

6 DON'T DO TOO MUCH ON TEST DAY

You've spent the last few days, weeks and months preparing for your test, so there's no need to beat yourself up about parallel parking now.



7 STAY OFF THE CAFFEINE

You might think you need all the coffee in the world after being awake all night worrying but drinking too much caffeine before your test can make you feel more agitated and nervous. Instead, drink plenty of water or something naturally calming such as a chamomile tea.



8 ARRIVE AT THE DPS EARLY

Get to the DPS about 15 minutes beforehand so you're not hurried or waiting too long.



9 GO TO THE BATHROOM

We don't have to elaborate, do we? Suffice to say, you don't want any distractions during your test.



10 REMEMBER, THERE IS NO RUSH

Your Road Test isn't designed to determine how fast you drive or you can reverse around a corner. Take your time, and remember that everything is going to be alright.



11 JUST CHILL & RELAX

Inhale, exhale & listen to your favorite music. Remember all the knowledge is in your brain. Pass the Road Test and get your Commercial Driver License.



May the FORCE be with you



GOOD LUCK on your Road Test



14803 Camino Rancho Dr Houston, TX 77083

713-858-0044

